

Mic

CMHT2152-28LFA

Platinum 5 MP TVI Audio over Coax Dual-Light Fixed Turret Camera



- High quality imaging with 5 MP, 2960 × 1665 resolution
- 2.8 mm fixed lens
- Up to 98 ft (30 m) IR distance for bright night imaging
- Up to 66 ft (20 m) white light range for night imaging
- One switchable port for four unique signals
- Water and dust resistance (IP67)
- Built-in microphone for Certain TVI DVRs





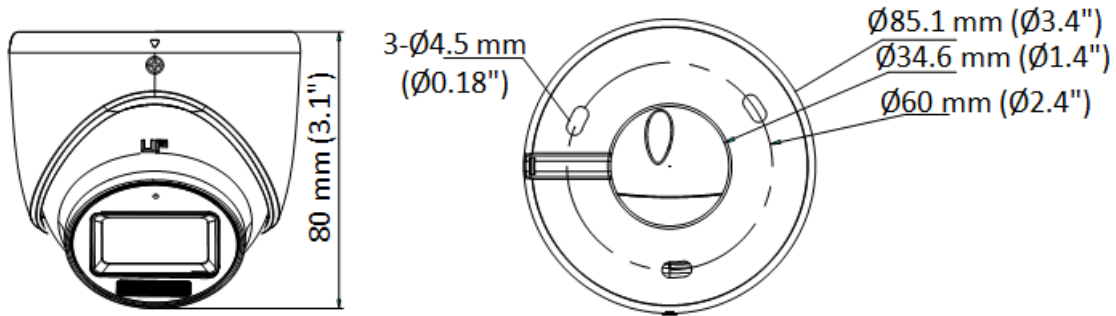

Specifications

| Camera | |
|------------------------------|--|
| Image Sensor | 3K CMOS |
| Max. Resolution | 2960 (H) × 1665 (V) |
| Min. Illumination | 0.01 Lux @ (F1.2, AGC on), 0 Lux with IR |
| Shutter Time | PAL: 1/25 to 1/50,000 sec.; NTSC: 1/30 to 1/50,000 sec. |
| Day & Night | ICR |
| Angle Adjustment | Pan: 0 to 360°, Tilt: 0 to 75°, Rotation: 0 to 360° |
| Signal System | PAL / NTSC |
| Lens | |
| Lens Type | 2.8 mm fixed focal lens |
| Focal Length & Field of View | 2.8 mm: Horizontal: 107°, vertical: 64°, diagonal: 129° |
| Lens Mount | M12 |
| Illuminator | |
| Supplemental Light Type | White Light, IR |
| Supplemental Light Range | IR: Up to 98 ft (30 m) White Light: Up to 66 ft (20 m) |
| Imaging | |
| Image Settings | Brightness, Sharpness, Smart IR |
| Frame Rates | TVI: 5 MP @ 20 fps, 4 MP @ 25 fps / 30 fps, 1080p @ 25 fps / 30 fps AHD: 5 MP @ 20 fps, 4 MP @ 25 fps / 30 fps CVI: 4 MP @ 25 fps / 30 fps CVBS: PAL / NTSC |
| Day / Night Mode | IR / White Light |
| Wide Dynamic Range (WDR) | Digital WDR |
| Image Enhancement | Yes |
| White Balance | Auto / Manual |
| AGC | Yes |
| Interface | |
| Video Output | Switchable TVI / AHD / CVI / CVBS |
| Audio | Microphone built-in, audio over coax cable |
| General | |
| Materials | Metal |
| Dimensions | 3.1 × Ø 3.4 in. (80 × Ø 85.1 mm) |
| Weight | Approx. 0.66 lbs (300 g) |
| Operating Conditions | -40° to 140° F (-40° to 60° C); humidity: 90% or less (non-condensation) |
| Language | English |
| Power Supply | 12 VDC ± 25% <i>*LTS recommends using one power adapter for each camera.</i> |
| Consumption | Max. 2.9 W |
| Certifications | |
| Protection | IP67 |

Dimensions

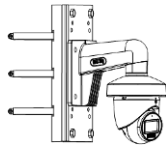
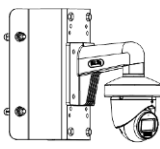
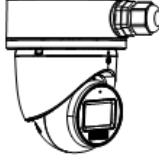

Accessories (Optional)

| LTB378 Vertical Pole Mount | LTB379 Corner Mount | LTB345 Junction box | LTB342-110T Wall mount |
|---|---|--|---|
|  |  |  |  |
|  |  |  |  |